

General Scheme:

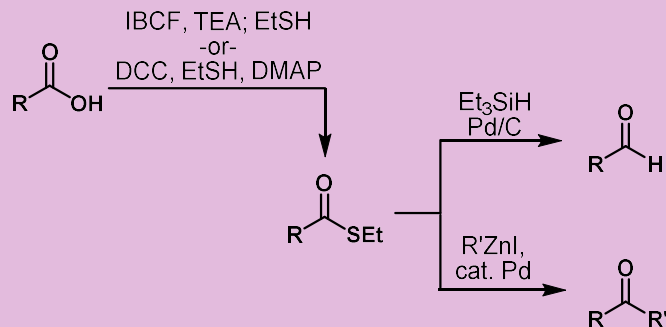

References:

J. Braz. Chem. Soc. **1998**, *9*, 381. *Aldrichimica ACTA* **2004**, *37*, 87.

Odorless Protocol:

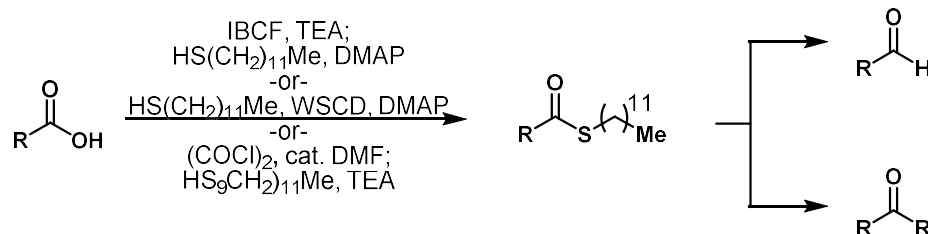

Synlett. **2004**, *3*, 477. DOI: 10.1055/s-2004-815427

Fukuyama Reduction:

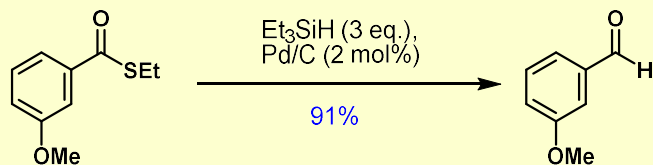

Mechanism:

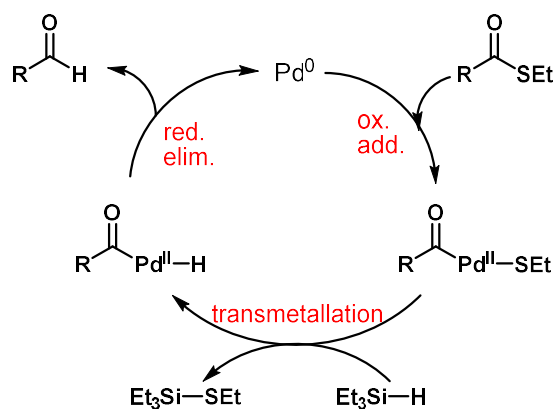

Tet. Lett. **2004**, *45*, 3219. DOI: 10.1016/j.tetlet.2004.02.130

Selected Examples from Substrate Scope:

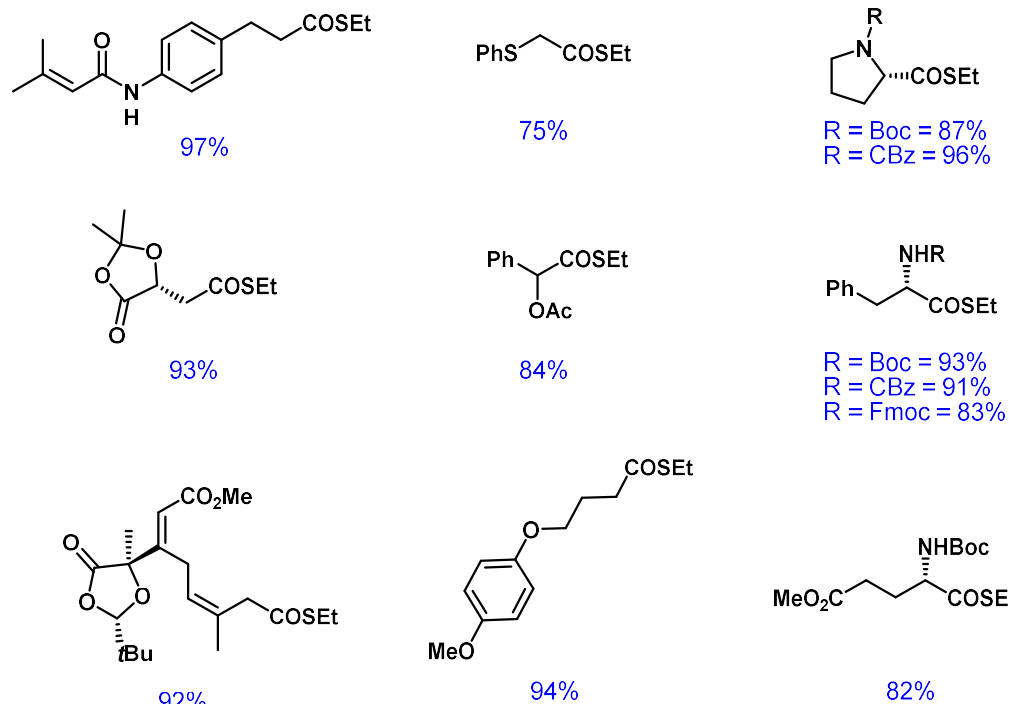

J. Am. Chem. Soc. **1990**, *112*, 7051. DOI: 10.1021/ja00175a043
Synthesis **2002**, *8*, 1121. DOI: 10.1055/s-2002-31969

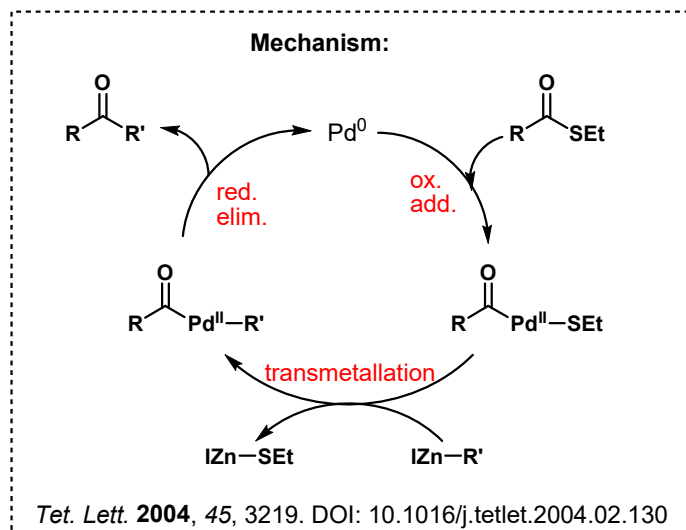
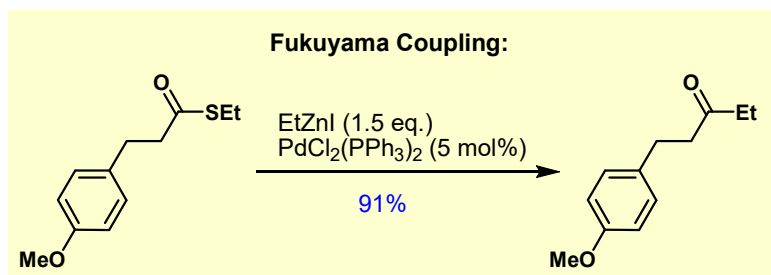

Selected Examples from Substrate Scope:

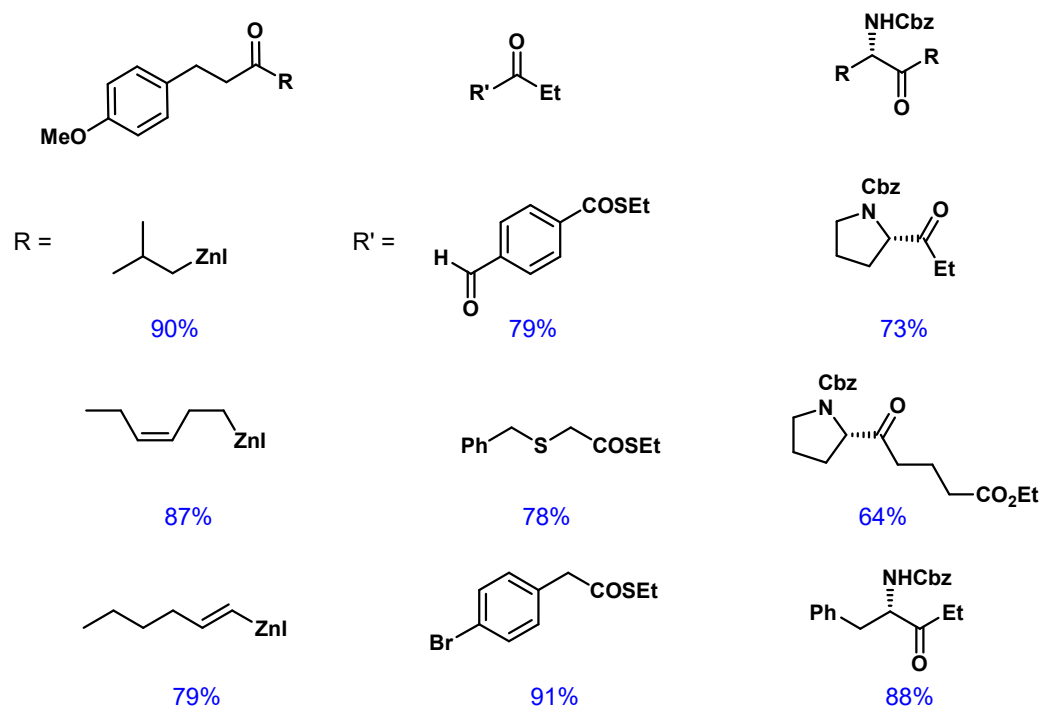

Tet. Lett. **1998**, 39, 3189. DOI: 10.1016/S0040-039(98)00456-0

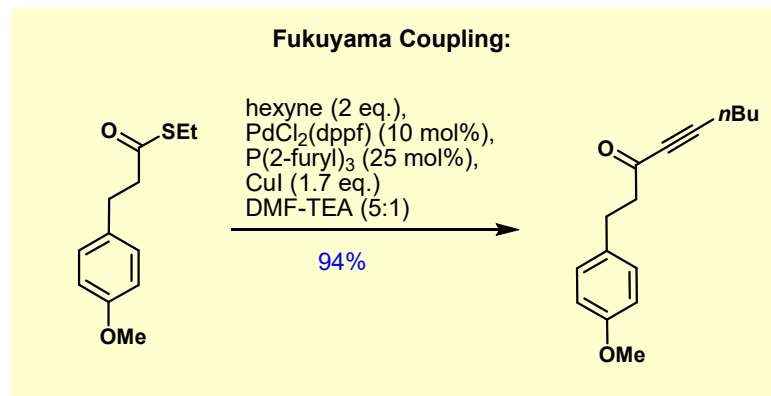

Selected Examples from Substrate Scope:

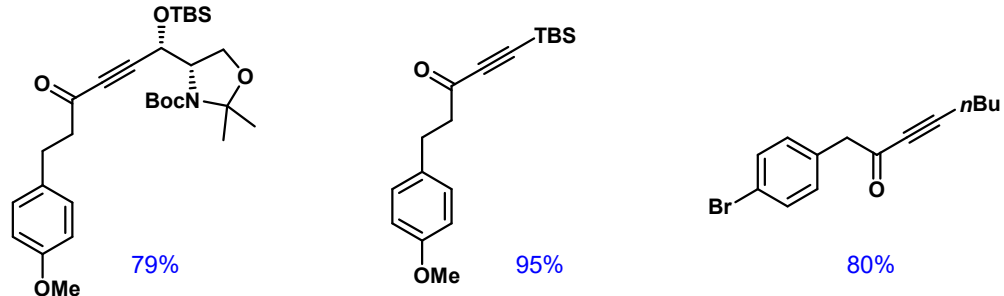

Synlett. **2003**, 10, 1512. DOI: 10.1055/s-2003-40861

Applications in Total Syntheses:

J. Am. Chem. Soc. **1990**, *112*, 7051. DOI: 10.1021/ja00175a043

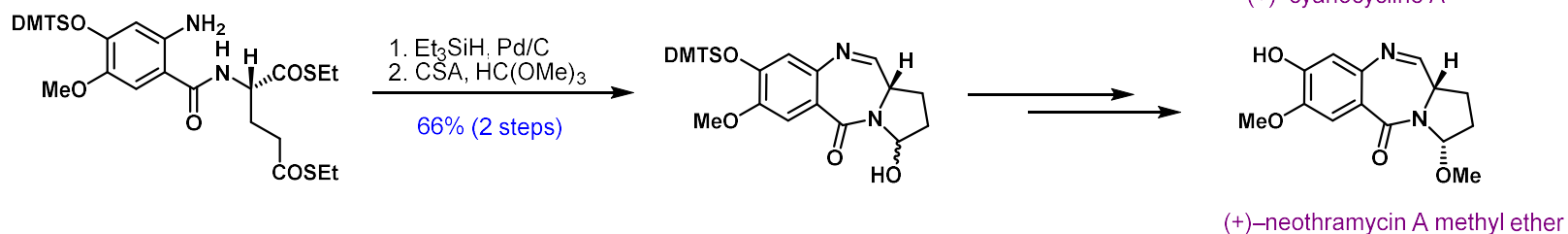
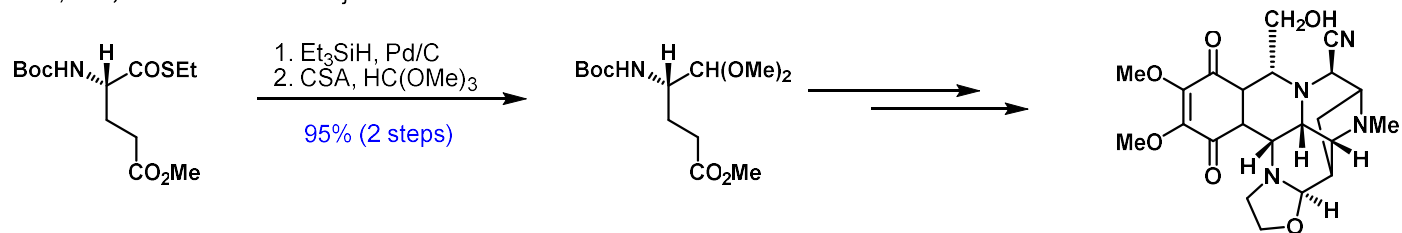

Tet. Lett. **2000**, *41*, 5099. DOI: 10.1016/S0040-4039(00)00781-4

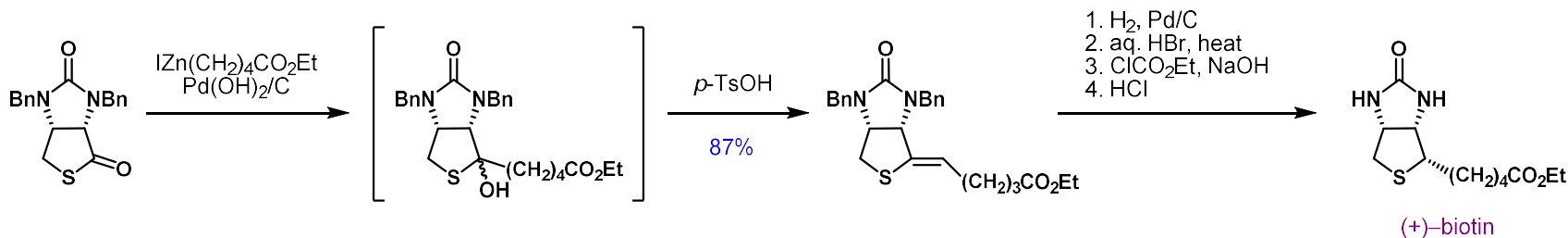

Tet. Lett. **1999**, *55*, 8671. DOI: 10.1016/S0040-4020(99)00438-X

